

Frigerio

MILLER DOUBLE SOFA

Design R&D Frigerio

Estremamente dinamico nell'estetica e nelle funzioni, Miller è concepito come spazio d'incontro. La scenografica versione bifacciale del divano Miller Double, riflesso di una socialità contemporanea e informale, è caratterizzata dagli schienali imbottiti anche sul retro per consentire l'aggancio delle sedute su entrambi i lati. Pensata per creare configurazioni a centro stanza perfette per arredare anche sofisticate lounge contract. La collezione di divani modulari Miller double permette di mixare liberamente gli elementi del programma creando soluzioni fortemente personalizzate capaci di ribaltare, arricchendola, la funzione classica del divano all'interno degli spazi, siano essi domestici o contract. Più che una collezione di sedute, Miller Double è un vero e proprio sistema d'arredo di divani modulari moderni dalla seduta confortevole.

Extremely dynamics in the aesthetic and functions, Miller is conceived as a space for encounter. The double-sided version of Miller Double sofa is scenographic, it is the reflection of contemporary and informal social relations, it features padded back also on the back part to allow the fitting of seat elements on both sides. Conceived to create configurations in the middle of a room, it is perfect to furnish also sophisticated contract lounge. The collection of modular sofa Miller Double allows to freely mix the elements of the programme to create strongly personalized solutions which are able to overturn, by enriching it, the classical sofa function within the domestic or contract areas. Much more than a collection of seating, Miller Double is a true and real furnishing sofa modular system with comfortable seating.

MILLER DOUBLE

Struttura: legno multistrato imbottito in poliuretano espanso indeformabile rivestito in tessuto protettivo accoppiato.
Cuscini seduta: poliuretano espanso indeformabile.
Piano seduta trapuntato: accoppiato a fibra sintetica.
Cuscini schienale: piuma d'oca (Assopiuma).
Piedini: neri.
Rivestimento: sfoderabile in tessuto, fisso in pelle. Rivestimento trapuntato sfoderabile e lavabile esclusivamente a secco.
Profilo: esclusivamente sul cuscino seduta, nello stesso materiale e colore del rivestimento. Su richiesta profilo in contrasto esclusivamente in Grosgrain.

ACCESSORI:

| **pouf volume:** collezione di pouf volume coordinati in differenti misure con rivestimento trapuntato in tessuto o pelle.
 | **tavolini volume pad:** volumi monoblocco in varie dimensioni in ceramica oppure rivestiti in cuoio.

Structure: plywood padded with non-deformable polyurethane foam covered with doubled protective fabric.
Seat cushions: non-deformable polyurethane foam.
Quilted top seat cover: doubled with synthetic fibre layer.
Back cushions: goose down (Assopiuma).
Feet: black.
Cover: removable in fabric, fix in leather. Quilted covers removable, dry clean only.
Piping: on seat cushion only, in the same material and colour as the cover. On demand piping in contrast exclusively in Grosgrain.

ACCESSORIES:

| **pouf volume:** collection of coordinated pouf volume in different sizes with quilted cover either in fabric or leather.
 | **small table volume pad:** monobloc volumes in different sizes or covered in hide leather.

MILLER DOUBLE TOP / OPEN

VERSIONE MILLER DOUBLE TOP: struttura con top imbottito e schienale sporgente, che servono da appoggio e contenimento per accessori.

ACCESSORI MILLER DOUBLE TOP:

Bracciolo CABINET
 Bracciolo VOLUME SOFT
 Bracciolo VOLUME PAD

Varianti: combinabile con gli altri elementi della collezione Miller.

VERSION MILLER DOUBLE TOP: structure with top and longer back suitable for supporting and containing accessories.

ACCESSORIES MILLER DOUBLE TOP:

Armrest CABINET
 Armrest VOLUME SOFT
 Armrest VOLUME PAD

Variants: to be combined with the other elements of the Miller Collection.

VERSIONE MILLER DOUBLE OPEN: struttura con schienale sporgente, che serve da contenimento accessori posizionati a terra.

ACCESSORI MILLER DOUBLE OPEN:

Bracciolo WOOD
 Bracciolo DAY LOW

Varianti: combinabile con gli altri elementi della collezione Miller.

VERSION MILLER DOUBLE OPEN: structure with longer back suitable for containing elements resting on floor.

ACCESSORIES MILLER DOUBLE OPEN:

Armrest WOOD
 Armrest DAY LOW

Variants: to be combined with the other elements of the Miller Collection.



MILLER DOUBLE SEDUTE / SEATS



SEDUTA LISCIA / PLAIN SEAT

Ogni elemento seduta può avere rivestimento liscio.

Each seat element could have a plain cover.



SEDUTA TRAPUNTATA / QUILTED SEAT

Ogni elemento seduta può avere un rivestimento con trapunta dedicata.

Each seat element could have a cover with a dedicated quilting.

MILLER DOUBLE TOP ELEMENTI TOP / TOP ELEMENTS



Terminali, chaises longue, dormeuses e pouf caratterizzati da struttura con top imbottito e schienale sporgente, che servono da appoggio e contenimento per i loro accessori, che sono privi di piedini e assicurati al top tramite calamite:

Bracciolo Volume Soft (imbottito e trapuntato)

Bracciolo Volume Pad (in gres porcellanato effetto marmo, rivestito in cuoio oppure impiallacciato)

Bracciolo Cabinet (impiallacciato nelle finiture della collezione Frigerio)

Terminals, chaises longues, dormeuses and poufs characterised by a structure with upholstered top and longer backrest, used to support and contain their accessories, which are without feet and secured to the top by magnets:

Volume Soft armrest (padded and quilted)

Volume Pad armrest (in gres porcelain marble effect, in hide leather or veneered)

Cabinet armrest (veneered in the finishes of the Frigerio collection)

VOLUME SOFT



VOLUME PAD



CABINET



MILLER DOUBLE OPEN ELEMENTI OPEN / OPEN ELEMENTS



Terminali, chaises longue e dormeuses caratterizzati da struttura con schienale sporgente, che serve da contenimento per gli accessori:

Bracciolo Day Low (parte trapuntata in tessuto o pelle e parte libreria in impiallacciato nelle finiture della collezione Frigerio. Basamento in metallo color brunito)

Bracciolo Wood (impiallacciato nelle finiture della collezione Frigerio. Basamento in metallo color brunito)

Terminals, chaises longues and dormeuses characterised by a structure with longer backrest, used to contain their accessories:

Day Low armrest (quilted part in fabric or leather and bookcase part veneered in the finishes of the Frigerio collection. Base in metal burnished colour)

Wood armrest (veneered in the finishes of the Frigerio collection. Base in metal burnished colour)

BRACCIOLO DAY LOW



BRACCIOLO WOOD



MILLER DOUBLE FULL BACK

Serie di elementi che hanno lo schienale interamente imbottito anche sul retro per consentire l'aggancio degli articoli "seduta" (senza schienale), consentendo la realizzazione di composizioni bifacciali. Gli elementi "seduta" non possono essere utilizzati come pouf in quanto, per motivi tecnici, sia l'imbottitura che il rivestimento sono rifiniti in modo particolare.

Struttura: legno multistrato imbottito in poliuretano espanso indeformabile rivestito in tessuto protettivo accoppiato.

Cuscini seduta: poliuretano espanso indeformabile.

Piano seduta trapuntato: accoppiato a fibra sintetica.

Cuscini schienale: piuma d'oca (Assopiuma).

Piedini: neri.

Rivestimento: sfoderabile in tessuto, fisso in pelle. Rivestimento trapuntato sfoderabile e lavabile esclusivamente a secco.

Profilo: esclusivamente sul cuscino seduta, nello stesso materiale e colore del rivestimento.

In caso di rivestimento in tessuto ALBA, LIPARI o RAVELLO, profilo disponibile esclusivamente in art. GROSGRAIN.

Collection of elements fully padded on both sides of the backrest to allow the fixing of the "seat elements" (without back), to create double-side compositions.

The seat elements cannot be used as poufs since for technical reasons both the padding and the covers are finished in a specific way.

Structure: plywood padded with non-deformable polyurethane foam covered with doubled protective fabric.

Seat cushion: non-deformable polyurethane foam.

Quilted top seat: doubled with synthetic fibre layer.

Back cushions: goose down (Assopiuma).

Feet: black.

Cover: removable in fabric, fix in leather. Quilted covers removable, dry clean only.

Piping: on seat cushion only, in the same material and colour as the cover.

In case of cover in fabric ALBA, LIPARI or RAVELLO, piping available exclusively in art. GROSGRAIN.

ELEMENTI CON RETRO INTERAMENTE IMBOTTITO + ELEMENTI SEDUTA / ELEMENTS WITH FULL PADDED BACK + SEAT ELEMENTS



MILLER DOUBLE SHAPED BACK

Serie di elementi che hanno lo schienale imbottito, ma sagomato sul retro per consentire l'aggancio degli articoli "seduta" (senza schienale), consentendo la realizzazione di composizioni bifacciali. Gli elementi "seduta" non possono essere utilizzati come pouf in quanto, per motivi tecnici, sia l'imbottitura che il rivestimento sono rifiniti in modo particolare.

Struttura: legno multistrato imbottito in poliuretano espanso indeformabile rivestito in tessuto protettivo accoppiato.

Cuscini seduta: poliuretano espanso indeformabile.

Piano seduta trapuntato: accoppiato a fibra sintetica.

Cuscini schienale: piuma d'oca (Assopiuma).

Piedini: neri.

Rivestimento: sfoderabile in tessuto, fisso in pelle.

Rivestimento trapuntato sfoderabile e lavabile esclusivamente a secco.

Collection of elements padded on both sides of the backrest, but shaped on the external part of the backrest, to allow the fixing of the "seat elements" (without back), to create double-side compositions.

The seat elements cannot be used as poufs since for technical reasons both the padding and the covers are finished in a specific way.

Structure: plywood padded with non-deformable polyurethane foam covered with doubled protective fabric.

Seat cushion: non-deformable polyurethane foam.

Quilted top seat: doubled with synthetic fibre layer.

Back cushions: goose down (Assopiuma).

Feet: black.

Cover: removable in fabric, fix in leather. Quilted covers removable, dry clean only.

ELEMENTI CON RETRO SAGOMATO + ELEMENTI SEDUTA TOP / ELEMENTS WITH SHAPED BACK + SEAT ELEMENTS TOP

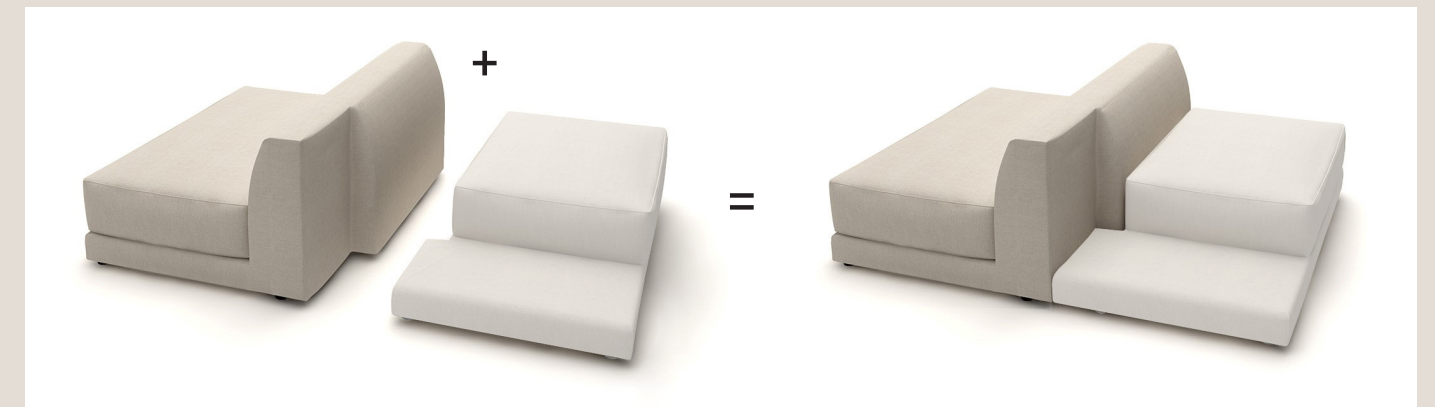

ELEMENTI CON RETRO SAGOMATO + ELEMENTI SEDUTA / ELEMENTS WITH SHAPED BACK + SEAT ELEMENTS



MILLER DOUBLE FULL BACK SOFA

Design R&D Frigerio

MILLER DOUBLE FULL BACK / d. 110 cm

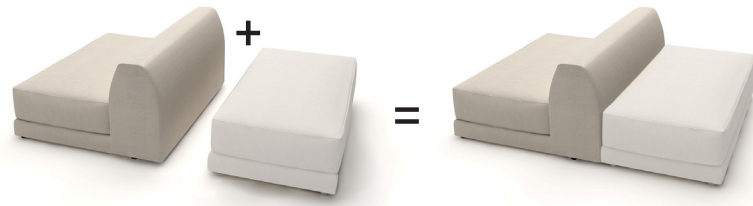
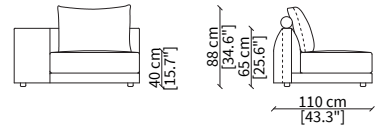

ELEMENTI CENTRALI / CENTRAL ELEMENTS

17000 17001 17005

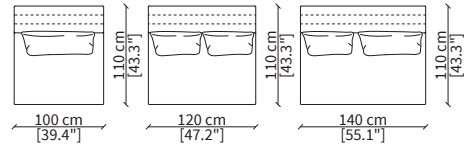

CHAISES LONGUE CENTRALI / CENTRAL CHAISES LONGUE

17002 17003

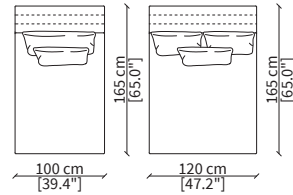

ELEMENTI TERMINALI TOP / TERMINAL TOP ELEMENTS

16800 16803

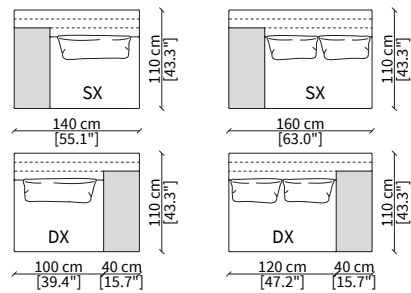

ELEMENTI TERMINALI OPEN / TERMINAL OPEN ELEMENTS

16900 16903

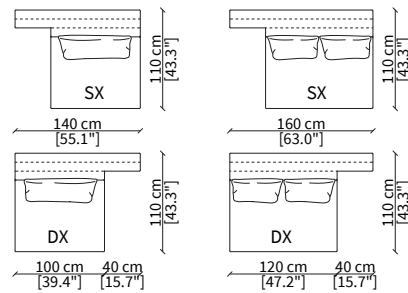

CHAISES LONGUE TOP

16806

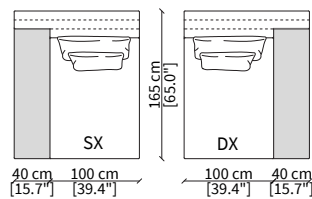

CHAISES LONGUE OPEN

16906

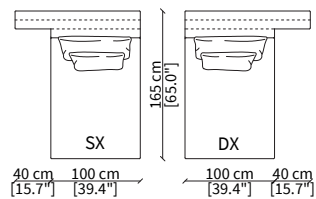

16809

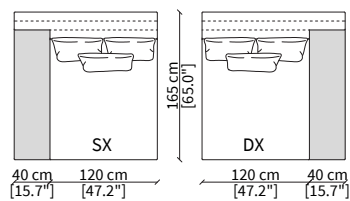

16909

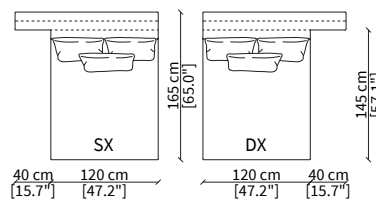

Dimensioni espresse in cm se non diversamente indicato.
L'Azienda si riserva il diritto di apportare modifiche ai modelli senza preavviso.
Tolleranza sulle misure indicate di +/- 2%.

Dimensions in centimeter if not differently indicated.
The Company reserves the right to change the models without any advance notice.
Tolerance on the given sizes +/- 2%.

MILLER DOUBLE FULL BACK SOFA

Design R&D Frigerio

MILLER DOUBLE FULL BACK ELEMENTI SEDUTA / SEAT ELEMENTS / d. 80 cm

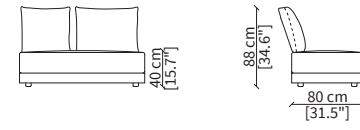

ELEMENTI SEDUTA / SEAT ELEMENTS

17100 17101 17102 17103

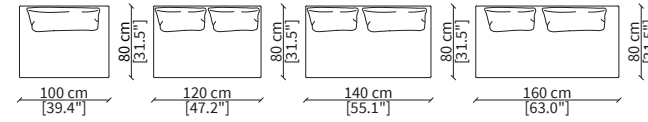

17200 17201 17202 17203

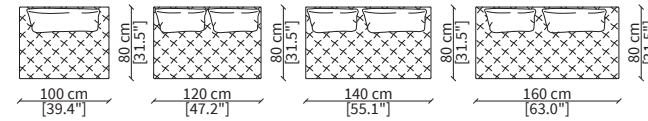

ELEMENTI SEDUTA CHAISE LONGUE / CHAISE LONGUE SEAT ELEMENTS

17104 17105

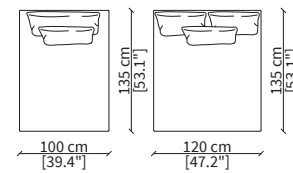

17204 17205

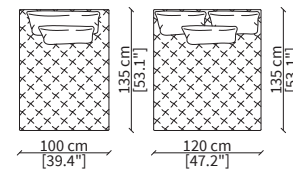

Dimensioni espresse in cm se non diversamente indicato.
L'Azienda si riserva il diritto di apportare modifiche ai modelli senza preavviso.
Tolleranza sulle misure indicate di +/- 2%.

Dimensions in centimeter if not differently indicated.
The Company reserves the right to change the models without any advance notice.
Tolerance on the given sizes +/- 2%.

MILLER DOUBLE SHAPED BACK SOFA

Design R&D Frigerio

MILLER DOUBLE SHAPED BACK / d. 110 cm

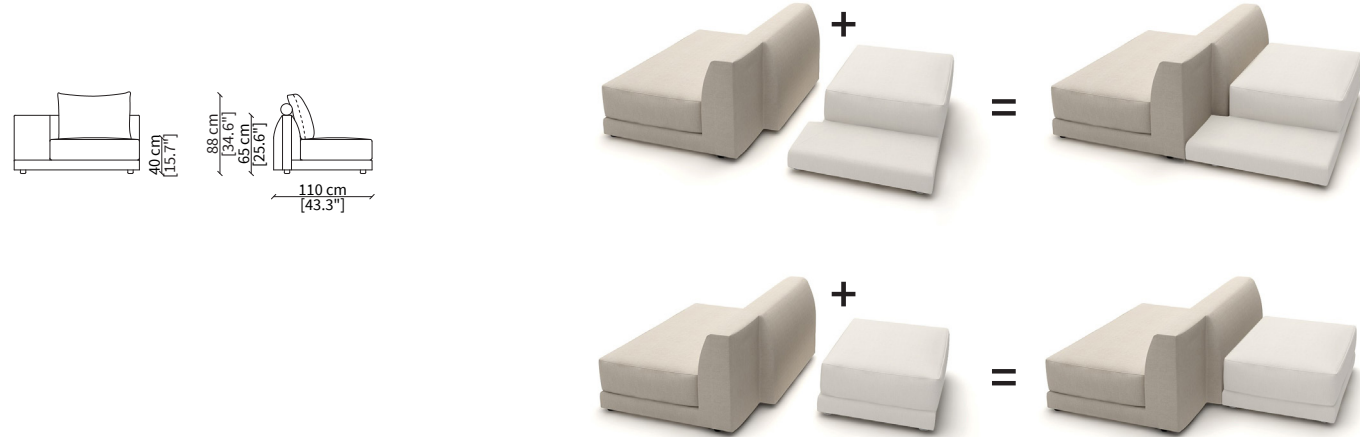

ELEMENTI TERMINALI TOP / TERMINAL TOP ELEMENTS

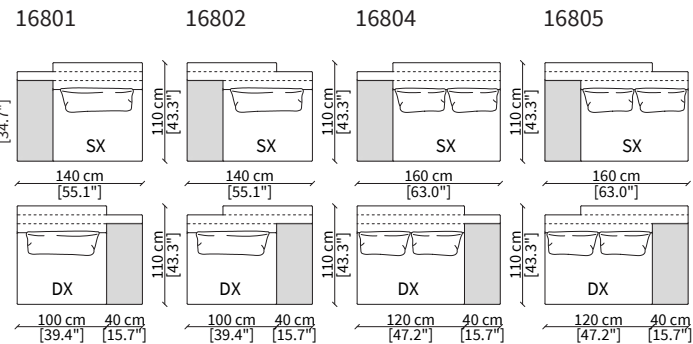

ELEMENTI TERMINALI OPEN / TERMINAL OPEN ELEMENTS

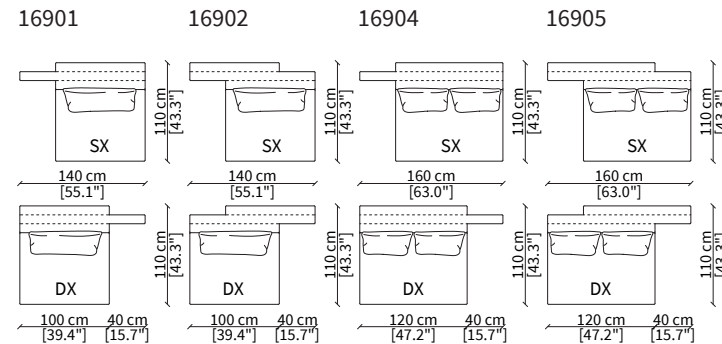

CHAISES LONGUE TOP

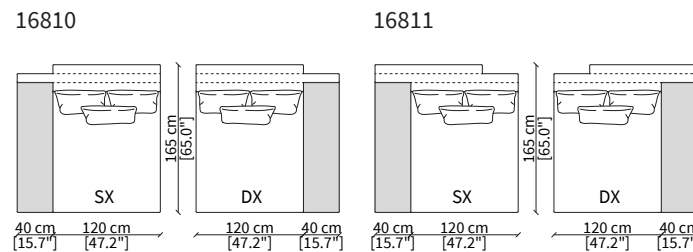
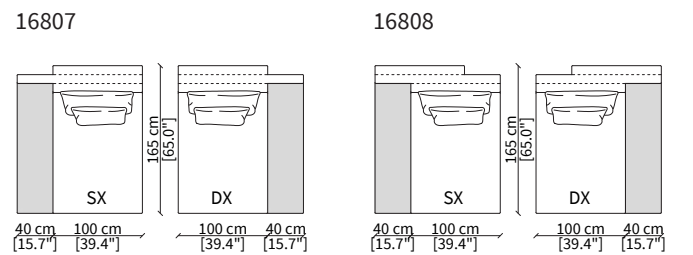

CHAISES LONGUE OPEN

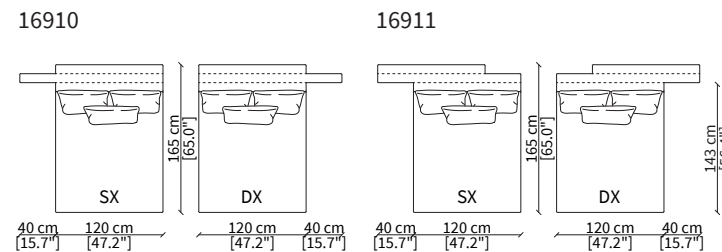
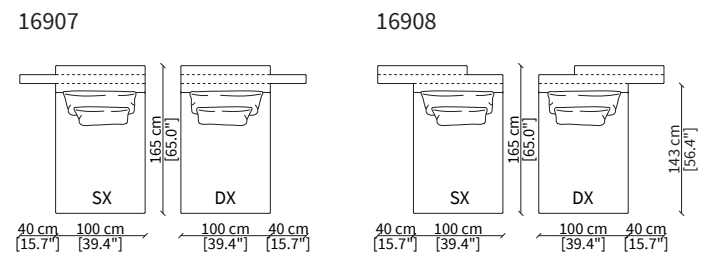

Dimensioni espresse in cm se non diversamente indicato.
L'Azienda si riserva il diritto di apportare modifiche ai modelli senza preavviso.
Tolleranza sulle misure indicate di +/- 2%.

Dimensions in centimeter if not differently indicated.
The Company reserves the right to change the models without any advance notice.
Tolerance on the given sizes +/- 2%.

MILLER DOUBLE SHAPED BACK SOFA

Design R&D Frigerio

MILLER DOUBLE SHAPED BACK ELEMENTI SEDUTA / SEAT ELEMENTS / d. 80 cm

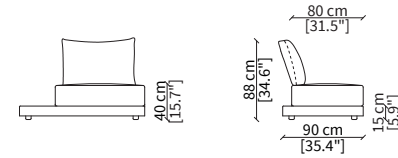

ELEMENTI SEDUTA TOP / SEAT ELEMENTS TOP

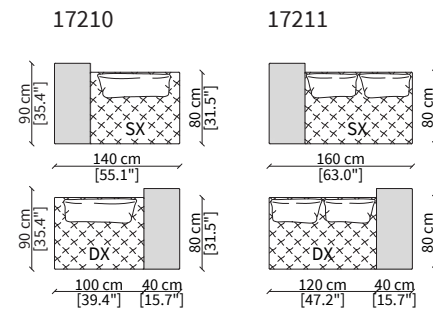
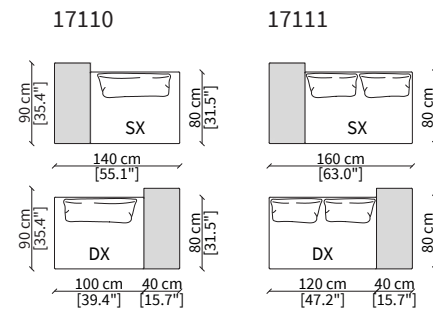

ELEMENTI SEDUTA CHAISE LONGUE TOP / CHAISE LONGUE SEAT ELEMENTS TOP

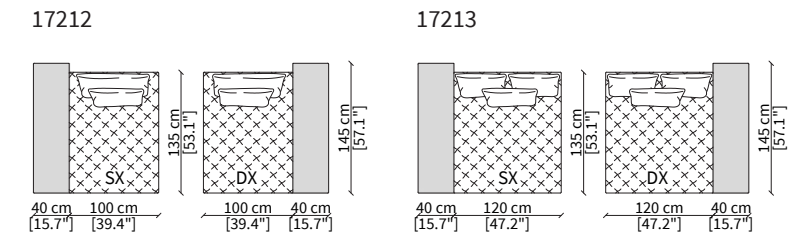
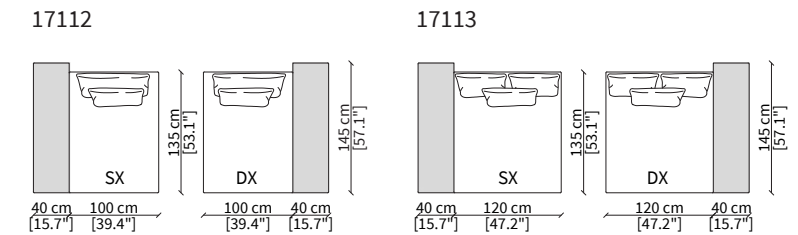

ELEMENTI SEDUTA / SEAT ELEMENTS

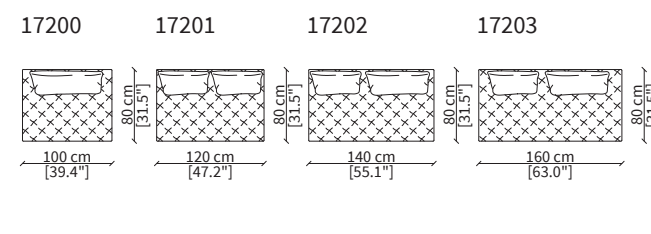
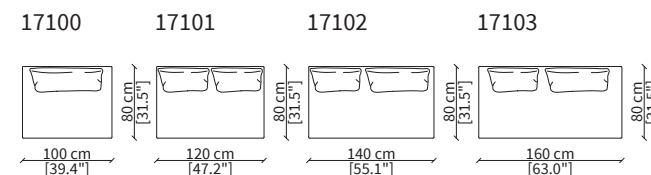

ELEMENTI SEDUTA CHAISE LONGUE / CHAISE LONGUE SEAT ELEMENTS

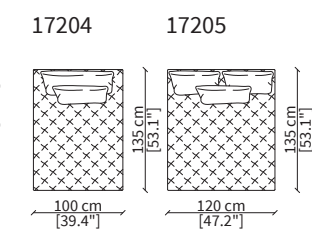
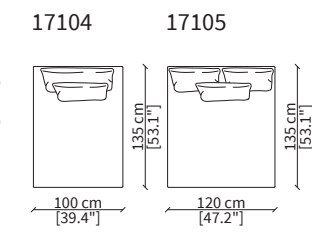

Dimensioni espresse in cm se non diversamente indicato.
L'Azienda si riserva il diritto di apportare modifiche ai modelli senza preavviso.
Tolleranza sulle misure indicate di +/- 2%.

Dimensions in centimeter if not differently indicated.
The Company reserves the right to change the models without any advance notice.
Tolerance on the given sizes +/- 2%.

MILLER DOUBLE SOFA

Design R&D Frigerio

MILLER DOUBLE ACCESSORI TOP E OPEN / TOP AND OPEN ACCESSORIES

ACCESSORI PER ELEMENTI TOP / ACCESSORIES FOR TOP ELEMENTS

VOLUME SOFT

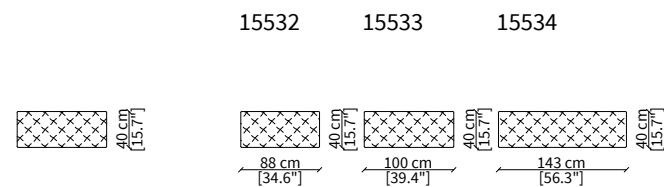

VOLUME PAD

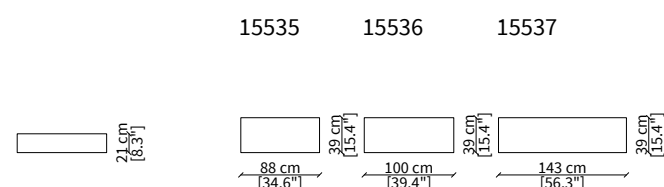

CABINET

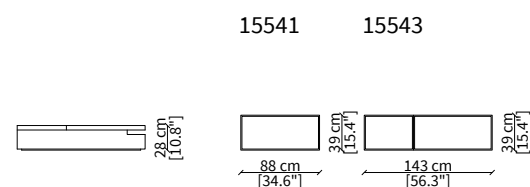

ACCESSORI PER ELEMENTI OPEN / ACCESSORIES FOR OPEN ELEMENTS

DAY LOW

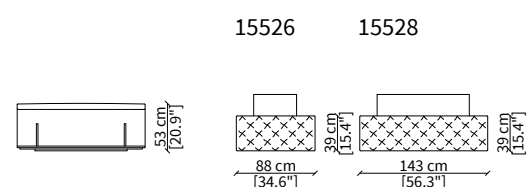

WOOD

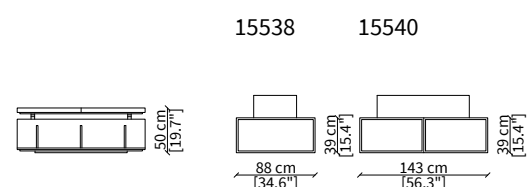

Dimensioni espresse in cm se non diversamente indicato.
L'Azienda si riserva il diritto di apportare modifiche ai modelli senza preavviso.
Tolleranza sulle misure indicate di +/- 2%.

Dimensions in centimeter if not differently indicated.
The Company reserves the right to change the models without any advance notice.
Tolerance on the given sizes +/- 2%.

MILLER DOUBLE SOFA

Design R&D Frigerio

MILLER DOUBLE ACCESSORI / ACCESSORIES

POUFS

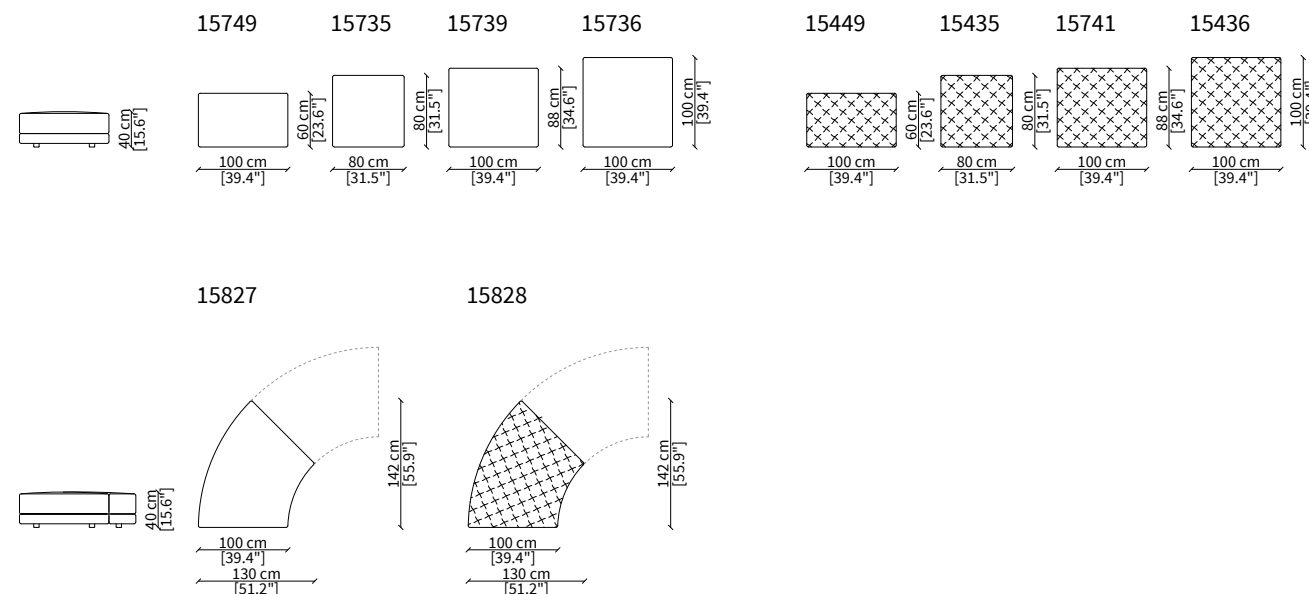

VOLUMI POUF / POUF VOLUMES

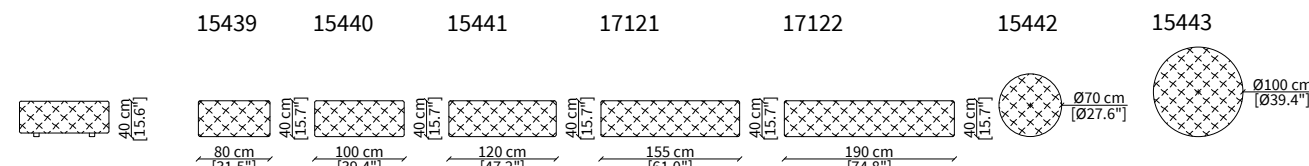

TAVOLINI / SMALL TABLES

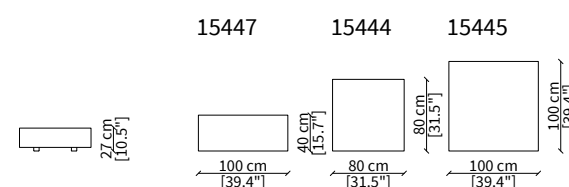

CUSCINI / CUSHIONS

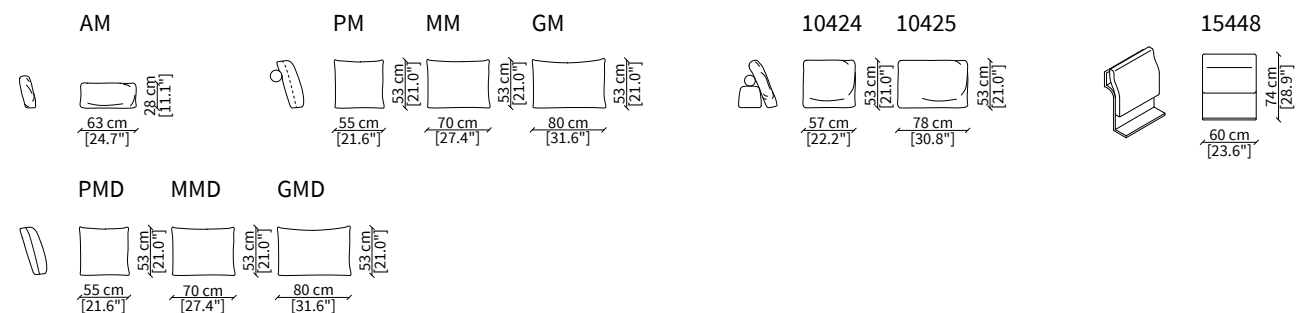

Dimensioni espresse in cm se non diversamente indicato.
L'Azienda si riserva il diritto di apportare modifiche ai modelli senza preavviso.
Tolleranza sulle misure indicate di +/- 2%.

Dimensions in centimeter if not differently indicated.
The Company reserves the right to change the models without any advance notice.
Tolerance on the given sizes +/- 2%.

MILLER DOUBLE SOFA Design R&D Frigerio

COMPOSIZIONE 1 / COMPOSITION 1

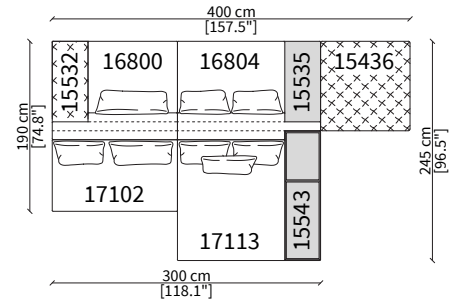

CODICI / CODES: **15532, 16800, 16804, 15535, 15436, 17102, 17113, 15543**

COMPOSIZIONE 2 / COMPOSITION 2

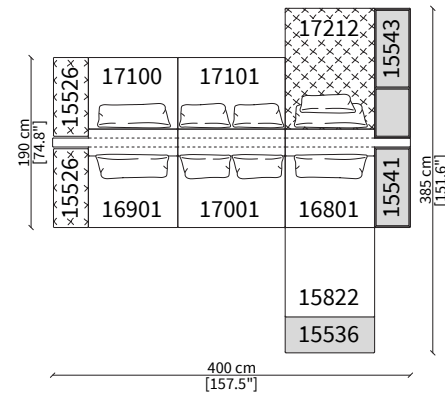

CODICI / CODES: **15526 x 2, 17100, 17101, 17212, 15543, 16901, 17001, 16801, 15541, 15822, 15536**

COMPOSIZIONE 5 / COMPOSITION 5

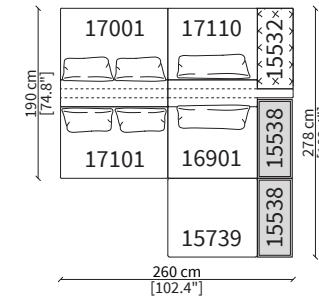

CODICI / CODES: **17001 17110, 17101, 16901, 15739, 15538 x 2, 15532**

COMPOSIZIONE 6 / COMPOSITION 6

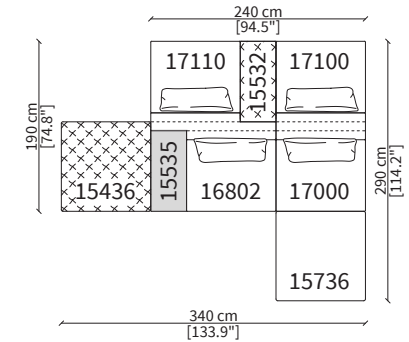

CODICI / CODES: **15436, 15535, 17110, 15532, 17100, 16802, 17000, 15736**

COMPOSIZIONE 3 / COMPOSITION 3

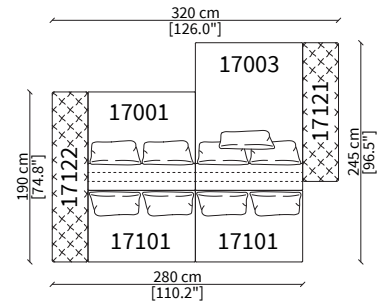

CODICI / CODES: **17122, 17001, 17003, 17121, 17101 x 2**

COMPOSIZIONE 4 / COMPOSITION 4

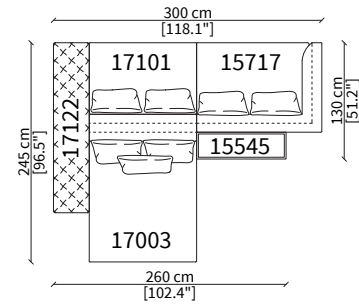

CODICI / CODES: **17122, 17101, 15717, 17003, 15545**

COMPOSIZIONE 7 / COMPOSITION 7

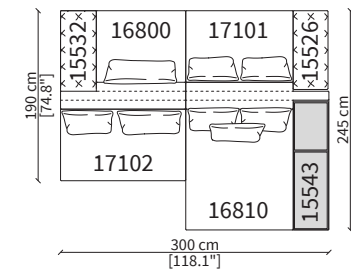

CODICI / CODES: **15532, 16800, 17101, 15526, 17102, 16810, 15543**

MILLER DOUBLE SOFA Design R&D Frigerio

COMPOSIZIONE 5 / COMPOSITION 5

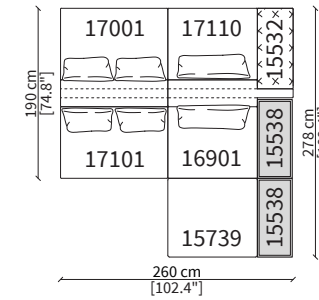

CODICI / CODES: **17001 17110, 17101, 16901, 15739, 15538 x 2, 15532**

COMPOSIZIONE 6 / COMPOSITION 6

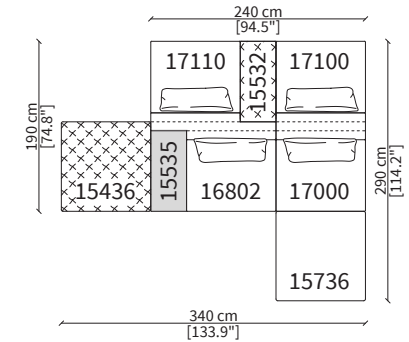

CODICI / CODES: **15436, 15535, 17110, 15532, 17100, 16802, 17000, 15736**

COMPOSIZIONE 7 / COMPOSITION 7

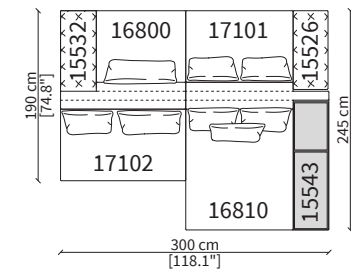

CODICI / CODES: **15532, 16800, 17101, 15526, 17102, 16810, 15543**

Per la gamma completa di materiali è possibile consultare il nostro sito web www.frigerio.com
The full range of materials can be found on our website at www.frigerio.com.

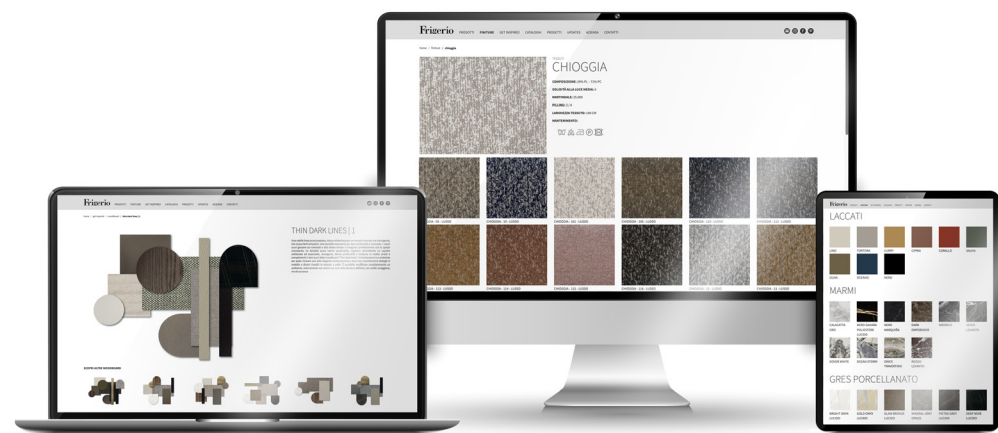

WWW.FRIGERIO.COM

Frigerio

Via Sant'Agata 63
22066 Mariano Comense (CO) - Italy
Tel. +39 031 5481225
info@frigerio.com
www.frigerio.com